

## ESTEAM CLEANING SYSTEMS

# **FLOOD MASTER MODELS**

## OWNER'S MANUAL

Congratulations on your selection of a new Flood Master, flood extractor built in Canada by "Esteam Cleaning Systems."

Our goal has been to produce the best high performance line of carpet cleaning equipment on the market today.

Reading your owners' manual will help to achieve maximum benefit from your investment.

## TABLE OF CONTENTS

	Page No.
Introduction to the Flood Master	1
Specifications	4
Maintenance	4
Safety Information	5
Operating Instructions	6
Trouble Shooting	9
Schematic Diagram	12
Warranty Registration	26
Warranty	27

## **INTRODUCTION**

Only the highest quality components go into our equipment, to deliver you strength and reliability in a long life, high performance machine. The Flood Master's housing is made of high impact, unbreakable polyethylene. We are so confident in the housing that we put an unlimited 3 year guarantee on this unit.

The Flood Master incorporates a unique dual 2 stage vacuum system. Two 2 stage vacuum motors hooked up in sequence produce 150 inches of water lift. To compliment the vacuum lift the Flood Master comes standard with a Wayne industrial pump which disposes up to 65 gallons per minute under vacuum.

The Flood Master is also available for carpet and upholstery cleaning with it's optional 150 or 200 PSI solution pumps.

The Flood Master's clean water solution tank and the dirty water recovery tank both have a 40 litre capacity. Built into the recovery the Flood Master comes standard with a high water automatic shut off. You never have to fear overfilling your recovery tank, as the vacuums will automatically stop extracting when the tank becomes full. The Flood Master is capable of handling any flood job large or small.

## SPECIFICATION FLOOD MASTER

<b>ELECTRICAL</b> Amp Volt	Two Cords 14 Amp per cord 115 Volts
<b>VACUUM MOTOR</b> Cfm's Vacuum lift	2 – 2 Stage 94 150" water Lift
<b>DUMP PUMP</b>	65 Gallons per minute 1/2 H.P. A/C
<b>SOLUTION PUMP</b> (Optional)	150 PSI or 200 PSI
<b>SOLUTION TANK</b> (Clean Water)	10.5 Gallons (40 Litres)
<b>RECOVERY TANK</b>	10.5 Gallons (40 Litres)
<b>LENGHT</b>	26 inches (66 Cm)
<b>WIDTH</b>	17 inches (43 Cm)
<b>HEIGHT</b>	34 inches (86 Cm)
<b>WEIGHT</b>	110 lbs (49.8 Kgs)

### MAINTENANCE

#### DAILY:

- Clean screen inside recovery tank.
- Ensure automatic shut off float ball is working properly.
- Rinse out recovery tank after use.
- Clean dirt and obstructions from the (recovery tank) drain valve rubber gaskets to prevent premature wear.
- Rinse out pump with clean water at conclusion of workday.
- Clean poly housing with a mild soap and water.

## MONTHLY:

- Clean air inlet and check exhaust port.

## YEARLY:

- We recommend that your unit be inspected by a qualified service technician once a year.

## PREVENTIVE MAINTENANCE:

Never store this unit in a place where there is a possibility of the temperature dropping below 0°C (32°F).

### **SAFETY INFORMATION**

1. Prior to inspection or repair of this machine, disconnect all electrical cords rendering the machine powerless. Failure to do so could result in serious or fatal injury.
2. Inspect unit daily for worn or damaged components e.g. frayed cord, loose plug, or a plug with missing ground pin, etc.
3. This unit should only be operated when in an upright position on a level surface.
4. Do not operate unit unless it is properly grounded in a 3 pin grounded outlet. Never bend or remove ground pin from plug.
5. Ensure filters and screens are free from lint or dirt.
6. Do not run unit if vacuum motors or carpet cleaning pump are wet. Allow sufficient time for motors to dry before plugging unit in.
7. Do not use solvent-based cleaning products in this extractor.
8. Keep air inlet and exhaust ports free from obstructions. Blocked air inlets or exhaust ports can cause the unit to over heat.
9. Do not use solution or recovery tanks for storing hoses, cords, or accessories.
10. When using electrical equipment around water it is important to wear rubber-soled shoes and keep machine properly grounded at all times. Failure to do so could result in a fatal electric shock.

## **OPERATING INSTRUCTIONS**

1. Attach vacuum and discharge hose to unit. Wand vacuum hose attaches to hose barb on lid of machine. Discharge hose attaches to barb on front of recovery tank next to Flood Master name plate.

**NOTE:** Discharge hose must go to a drain.

2. Insert power cord plugs into 3 pin grounded outlet, separate circuits are required.
3. Turn vacuums and discharge pump power switches on.
4. Using either the flood wand or just the vacuum hose begin to extract water.
5. As the water level rises in the recovery tank the industrial discharge pump will discharge the water through the discharge hose connected to a drain at the rate of up to 30 gallons per minute.
6. If water entering the recovery tank is at a faster rate than the discharge pump is pumping to the drain, the vacuum motors will shut off for approximately 5-7 seconds. This will allow the discharge pump to evacuate the recovery tank. Vacuum motors will automatically turn back on and continue extracting water from desired area once the water in recovery tanks is evacuated.

## **OPERATING INSTRUCTIONS FOR CLEANING**

**NOTE:** Machine must be equipped with optional pump.

1. 150 or 200 PSI Pump Priming Instructions:
  - Fill fresh water tank
  - Attach prime hose to quick connect on machine
  - Place the other end of prime hose into vacuum port and hold
  - turn vacuum and pump switches on
  - Once a continuous flow of water is being drain through the prime hose, this indicates pump is primed
  - Turn off vacuum and pump switches and disconnect prime hose
  - Connect solution hose and vac hose to machine
  - Turn vacuum and pump switches on
  - Machine is ready to use.
2. Premix cleaning solution with hot water in a 20 litre pail. Pour mixed solution in solution tank of unit.

**NOTE:** Do not mix more solution than you will need for the job.

3. Connect vacuum and solution hoses to unit, ensure rubber plug is in discharge hose barb on front of unit next to Flood Master name plate.
4. Insert power cord plugs into 3 pin grounded outlets. Separate circuits are required.

### **OPERATING INSTRUCTION (CONTINUED)**

5. We recommend the use of a liquid defoamer, to prevent the machine from prematurely shutting off due to excess foam in the recovery tank. Turn on vacuums and pour approximately ¼ cup of Esteam Liquid Defoamer into the end of the vacuum hose.

6. Connect vacuum and solution hoses to the carpet cleaning wand.

**NOTE:** Do not turn on discharge pump switch for carpet cleaning.

7. Proceed to clean carpets.

**NOTE:** To prevent overwetting we recommend two dry passes (vacuum only) for every one wet pass (applying solution to carpet).

7. When the recovery tank becomes full, vacuums will automatically stop extracting. At this time switch unit off. Drain the recovery tank by pulling up on drain valve on front of machine.

**NOTE:** Ensure that the screen on the stand pipe inside recovery tank is free from any obstructions. Be sure to close drain valve before resuming cleaning.

8. To empty solution tank remove vacuum hose from wand. Turn one vacuum on and extract extra solution from solution tank into recovery tank, then drain recovery tank.

**NOTE:** Do not completely submerge end of vacuum hose into solution. Allow some air to enter end of vacuum hose with liquid.

9. When the job is completed, empty and rinse out the solution and recovery tanks. Allow vacuums to run for 3 to 5 minutes. This will eliminate all moisture from vacuums assuring long vacuum life.

**WARNING:** When using electrical equipment around water it is important to wear rubber soled shoes and to keep machine properly grounded at all times. Failure to do so could result in a fatal electric shock.

# FLOOD MASTER MODELS



**MODEL FM001  
FLOOD MASTER  
NO PUMP**

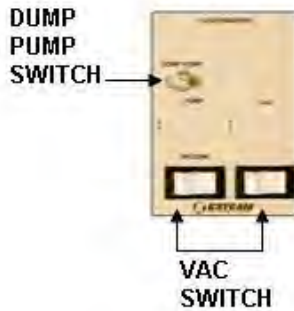

**MODEL FM100 & FM150  
FLOOD MASTER C/W PUMP  
100PSI OR 150PSI**

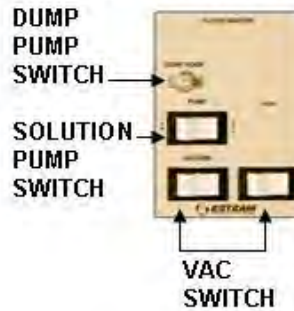

**MODEL FM200  
FLOOD MASTER C/W  
PUMP 200 PSI**

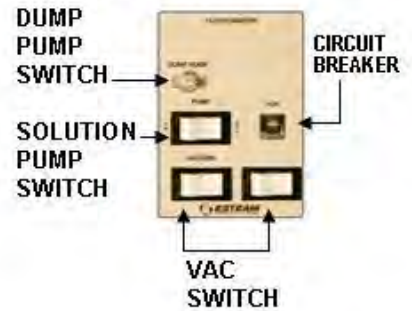



# TROUBLE SHOOTING

**WARNING:** Prior to inspection or repair of this machine, disconnect all electrical cords rendering the machine powerless. Failure to do so could result in serious or fatal injury.

<b>PROBLEM</b>	<b>CAUSE</b>	<b>SOLUTION</b>
1. Entire unit will not operate	1. Unit not plugged in	1. Connect unit to 3 pin grounded outlets
	2. Blown fuse or braker For plug outlet	2. Check fuse panel for blown fuse
	3. Loose wiring	3. See dealer
2. Discharge pump will not run	1. Power cord not Plug in	1. Connect unit to 3 pin grounded outlet
	2. Switch not turned on	2. Turn on Switch
	3. Loose wiring	3. See dealer
	4. Pump defective	4. See dealer
3. Vacuum will not run While in cleaning mode	1. Recovery tank full	1. Drain recovery tank
	2. switch not turned on	2. Turn on switch
	3. Broken switch	3. See dealer
	4. Loose wiring	4. See dealer
	5. Blocked rotor	5. See dealer
4. Vacuum will not run during water extraction	1. Discharge pump switch not turn on (recovery tank full)	1. Turn on Discharge pump switch
	2. Float switch not working properly	2. See dealer
	3. Broken switch	3. See dealer
	4. Loose wiring	4. See dealer
	5. Blocked rotor	5. See dealer

## TROUBLE SHOOTING (CONTINUED)

<b>PROBLEM</b>	<b>CAUSE</b>	<b>SOLUTION</b>
5. Carpet cleaning pump runs but does not pump solution	1. Out of solution	1. Fill solution tank with solution
	2. Pump inlet screen plugged	2. Clean inlet screen
	3. Pump was not properly primed	3. Prime pump using priming hose
	4. Kink in solution hose	4. Remove kink
	5. Plugged jet or quick connect	5. Remove blockage
	6. Internal (inside machine) or external solution line damaged and leaking	6. See dealer
6. Carpet cleaning pump runs but has loss of pressure	1. Partial kink in solution hose	1. Remove kink
	2. Partial blockage in solution hose	2. Remove blockage
	3. Jet orifice opening on cleaning wand is too large	3. Total jet opening for 100 PSI pump should be .06 Or .08, for 150 PSI & 200 PSI Pump should be .03
	4. Pressure regulator valve components wearing out	4. See dealer
	5. Internal pump components wearing out	5. See dealer
7. Vacuum operates but has poor or no suction	1. Recovery tank full	1. Drain recovery tank
	2 Vacuum hose plugged	2. Locate and remove blockage
	3. Wand plugged	3. Locate and remove blockage
	4. Exhaust port blocked	4. Locate and remove Blockage
	5. Front drain valve left open after draining recovery tank	5. Close recovery tank drain valve on front of machine
	6. Excess foam in recovery tank	6. Add defoamer to recovery tank
8. Machine spits water out of exhaust port	1. Float switch not working properly	1. Check auto shut off float switch for proper operation

## TROUBLE SHOOTING (CONTINUED)

<b>PROBLEM</b>	<b>CAUSE</b>	<b>SOLUTION</b>
9. Machine blowing excessive amounts of water out of exhaust ports	1. Damaged (leaking) recovery tank fittings	1. Immediately shut unit down. Bring unit to a dealer for service
10. Water accumulating in bottom electrical component area	1. Inside solution line leaking	1. Immediately shut unit down. Bring unit to a dealer for service
	2. Pump leaking	2. Immediately shut unit down. Bring unit to a dealer for service
	3. Solution or recovery tank leaking from above	3. Immediately shut unit down. Bring to a dealer for service

# MODEL FM001

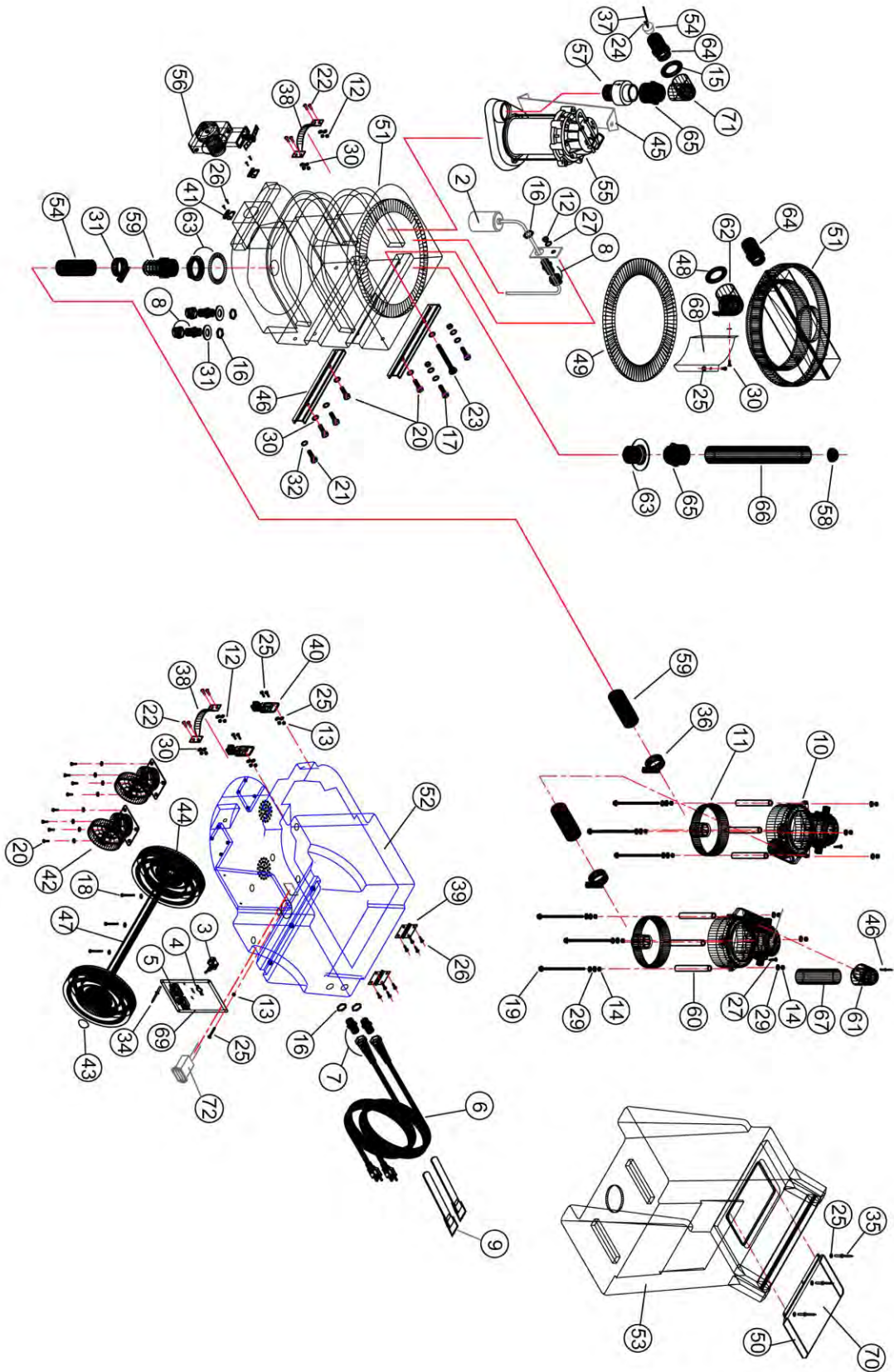

## FM001 PARTS LIST

REF	PART NO.	DESCRIPTION	NOTES:
1	260-038-50	Vac hose –Blue 50' 1-1/2"	Not Shown
2	305-200	Switch, Float (Up) No Plug	
3	305-210	Switch, Toggle	
4	305-225	Switch Plate, ON/OFF	
5	305-230	Switch, Rocker 20 Amp	
6	315-015	Cord, 25' Black 14/3 SJTW-A	
7	335-005	Strain Relief, 12 Gauge	
8	335-015	Strain Relief, 16 Gauge	
9	350-005	Strap Velcro	
10	355-451	Vacuum, 2 Stg (C/W: 355-405)	
11	355-405	Vac Cap, Straight	
12	400-115	Locknut, 1/4 x 20 Nylon SS	
13	400-130	Locknut, 10 x 24 Nylon SS	
14	400-135	Locknut, 1/4 x 20 Nylon Zinc	
15	415-420	Machined Washer 1-7/8	
16	400-165	Locknut, 1/2"	
17	405-010	Bolt, 1/4 x 1 SS	
18	405-020	Bolt, 1/4 x 1-1/4 SS	
19	405-065	Bolt, 1/4 x 6 Stove Zinc	
20	405-615	CS, 1/4 x 1/2 SS (Hex HD)	
21	405-620	CS, 1/4 x 3/4 SS (Hex HD)	
22	410-005	MS, 1/4 x 1 Phil SS Flat/H	
23	410-020	MS, 1/4 x 1-3/4 Phil SS Flat/H	
24	410-125	SMS, 8 x 5/8 Pan Rob. S.S.	
25	410-160	MS, 10-24 x 3/4 Pan PH SS	
26	410-205	MS, 10-32 x 1/2 Panphil SS	
27	410-225	SMS, 10 X 1/2 Pan Rob. Zinc	
28	415-115	FW, 10 SS	
29	415-120	FW, 1/4 Zinc	
30	415-125	FW, 1/4 SS	
31	415-185	FW, 3/4 SS	
32	415-305	FNDW, 1/4 SS	
33	420-055	Rivet, AL/AL #46	
34	420-105	Rivet, AL/ST #66	
35	420-151	Rivet, AL/AL Fullysealed #68	
36	425-010	Clamp, #20 Hose 13/16 x 1 3/4	
37	430-010	Chain, 1/4" Brass	
38	435-015	Handle, Brass/Chrome	
39	440-006	S.S. Hinge 2" x 2"	
40	445-015	Latch, Machine	
41	445-020	Latch, Striker	
42	455-705	Caster, 4" Swivel	
43	455-052	Wheel Cap Dome	
44	455-057	Wheel, 8" Grey/Black Hub	

45	465-051	BRKT, FM Pump	
46	465-065	Brace, Ninja Tank	
47	470-051	Axel, Ninja HD	
48	475-010	Gasket, Rubber - 1 1/2" Dump Valve	
49	475-030	Gasket, Lid 3/8"	
50	475-040	Gasket, 1/8 x 1"	
51	495-021C	Rec Tank & Lid Ninja	
52	495-035	Base, Ninja	
53	495-040	Sol Tank Ninja	
54	498-010	Plug, Rubber #7	
55	525-020	Pump, Wayne 110v	
56	545-100	Dump Valve, 1 1/2"	
57	550-011	Check Valve, 1-1/2" ABS	
58	560-120	Strainer	
59	570-010	Vac Hose 1 1/2" Wire Reinforced	
60	572-041	L.P. Hose 3/8"	
61	590-010	PVC Elbow 1 1/4" 90, S x S	
62	590-020	PVC ELB 1 1/2" 90, S x FIPT	
63	590-205	PVC Wall Fitting, 1 1/2"	
64	590-405	PVC Hose Barb 1 1/2" x MPT	
65	590-415	PVC Adpt 1 1/2", S x MPT	
66	595-005	ABS Pipe, 1 1/2"	
67	595-110	PVC Pipe, 1 1/4"	
68	845-007	Baffle, S/S	
69	845-030	Switch Plate	
70	845-041	Solution Tank Cover (Plastic)	
71	590-019	PVC Elbow 1-1/2", 90 FPT x FPT	
72	360-111	Hour Meter <b>(Optional)</b>	

# MODEL FM150 & FM200D

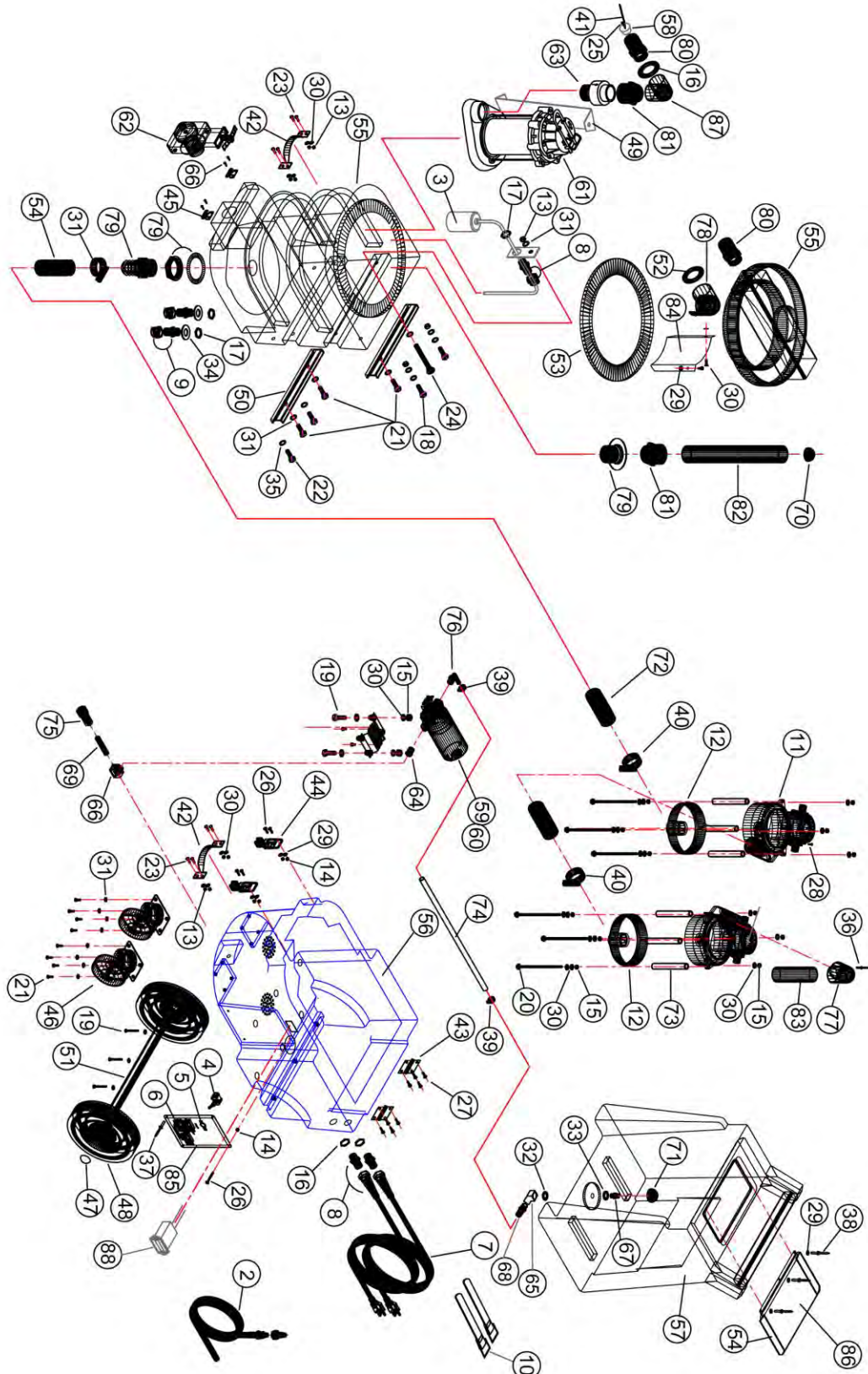

## FM150 & FM200D PARTS LIST

REF	PART NO.	DESCRIPTION	NOTES:
1	260-038-50	Vac hose –Blue 50' 1-1/2"	Not Shown
2	263-105	Prime Line 4" (Model FM150 only)	
3	305-200	Switch, Float (Up) No Plug	
4	305-210	Switch, Toggle	
5	305-225	Switch Plate, ON/OFF	
6	305-230	Switch, Rocker 20 Amp	
7	315-015	Cord, 25' Black 14/3 SJTW-A	
8	335-005	Strain Relief, 12 Gauge	
9	335-015	Strain Relief, 16 Gauge	
10	350-005	Strap Velcro	
11	355-451	Vacuum, 2 Stg (C/W: 355-405)	
12	355-405	Vac Cap, Straight	
13	400-115	Locknut, 1/4 x 20 Nylon SS	
14	400-130	Locknut, 10 x 24 Nylon SS	
15	400-135	Locknut, 1/4 x 20 Nylon Zinc	
16	415-420	Machined Washer 1-7/8	
17	400-165	Locknut, 1/2"	
18	405-010	Bolt, 1/4 x 1 SS	
19	405-020	Bolt, 1/4 x 1-1/4 SS	
20	405-065	Bolt, 1/4 x 6 Stove Zinc	
21	405-615	CS, 1/4 x 1/2 SS (Hex HD)	
22	405-620	CS, 1/4 x 3/4 SS (Hex HD)	
23	410-005	MS, 1/4 x 1 Phil SS Flat/H	
24	410-020	MS, 1/4 x 1-3/4 Phil SS Flat/H	
25	410-125	SMS, 8 x 5/8 Pan Rob. S.S.	
26	410-160	MS, 10-24 x 3/4 Pan PH SS	
27	410-205	MS, 10-32 x 1/2 Panphil SS	
28	410-225	SMS, 10 X 1/2 Pan Rob. Zinc	
29	415-115	FW, 10 SS	
30	415-120	FW, 1/4 Zinc	
31	415-125	FW, 1/4 SS	
32	415-155	FW, 1/2 SS (Stand/Max OD)	
33	415-156	FW, 1/2 SS (1-3/8" OD)	
34	415-185	FW, 3/4 SS	
35	415-305	FNDW, 1/4 SS	
36	420-055	Rivet, AL/AL #46	
37	420-105	Rivet, AL/ST #66	
38	420-151	Rivet, AL/AL Fullysealed #68	
39	425-005	Clamp #8	
40	425-010	Clamp, #20 Hose 13/16 x 1 3/4	
41	430-010	Chain, 1/4" Brass	
42	435-015	Handle, Brass/Chrome	
43	440-006	S.S. Hinge 2" x 2"	
44	445-015	Latch, Machine	



45	445-020	Latch, Striker	
46	455-075	Caster, 4" Swivel	
47	455-052	Wheel Cap Dome	
48	455-057	Wheel, 8" Grey/Black Hub	
49	465-051	BRKT, FM Pump	
50	465-065	Brace, Ninja Tank	
51	470-051	Axel, Ninja HD	
52	475-010	Gasket, Rubber - 1 1/2" Dump Valve	
53	475-030	Gasket, Lid 3/8"	
54	475-040	Gasket, 1/8 x 1"	
55	495-021C	Rec Tank & Lid Ninja	
56	495-035	Base, Ninja	
57	495-040	Sol Tank Ninja	
58	498-010	Plug, Rubber #7	
59	511-105	Pump, 150PSI (Model FM150)	
60	511-106	Pump, 200PSI (Model FM200)	
61	525-020	Pump, Wayne 110v	
62	545-100	Dump Valve, 1 1/2"	
63	550-011	Check Valve, 1-1/2" ABS	
64	555-024	Bushing, 3/8 M x 1/4 F	
65	555-182	Elbow 45, 1/4" FEM. Extruded	
66	555-208	Elbow 90, 1/4 Street Extruded	
67	555-272	Hex Nipple 1/4	
68	555-370	Hose Barb 1/2 Barb x 1/4 MPT	
69	555-424	Long Nipple, 1/4 x 2-1/2	
70	560-030	Screen, Acorn	
71	560-120	Strainer	
72	570-010	Vac Hose 1 1/2" Wire Reinforced	
73	572-041	L.P. Hose 3/8"	
74	572-155	Polyspring Hose, 1/2	
75	580-010	Q.C. 1/4 FEM (Closed)	
76	585-110	Nylon 90 Barb 1/2 x 3/8 NPT	
77	590-010	PVC Elbow 1 1/4" 90, S x S	
78	590-020	PVC ELB 1 1/2" 90, S x FIPT	
79	590-205	PVC Wall Fitting, 1 1/2"	
80	590-405	PVC Hose Barb 1 1/2" x MPT	
81	590-415	PVC Adpt 1 1/2", S x MPT	
82	595-005	ABS Pipe, 1 1/2"	
83	595-110	PVC Pipe, 1 1/4"	
84	845-007	Baffle, S/S	
85	845-030	Switch Plate	
86	845-041	Solution Tank Cover (Plastic)	
87	590-019	PVC Elbow 1-1/2, 90 FPT x FPT	
88	360-111	Hour Meter (Optional)	

# FM001 WIRING

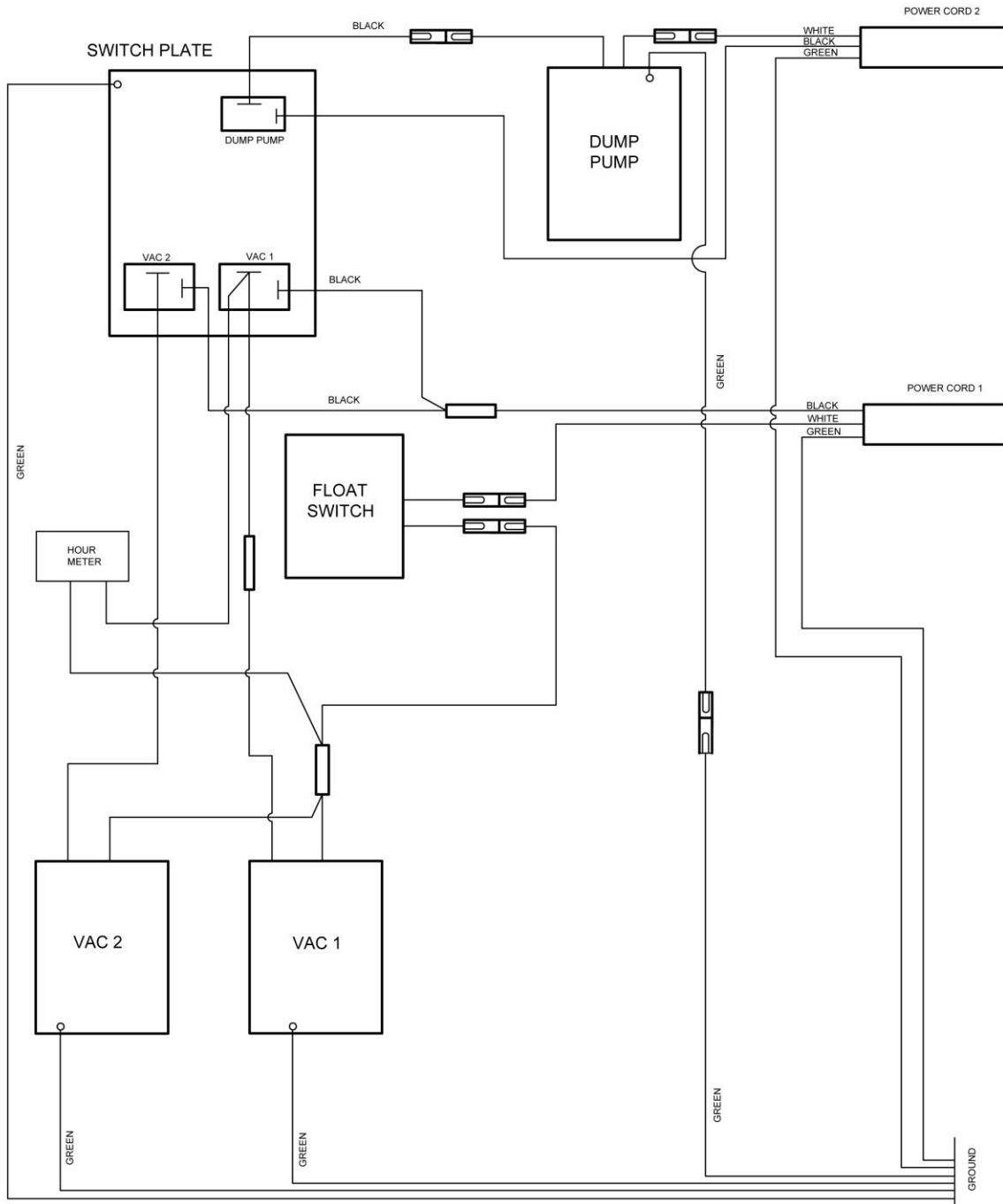

# FM150 & F200 WIRING

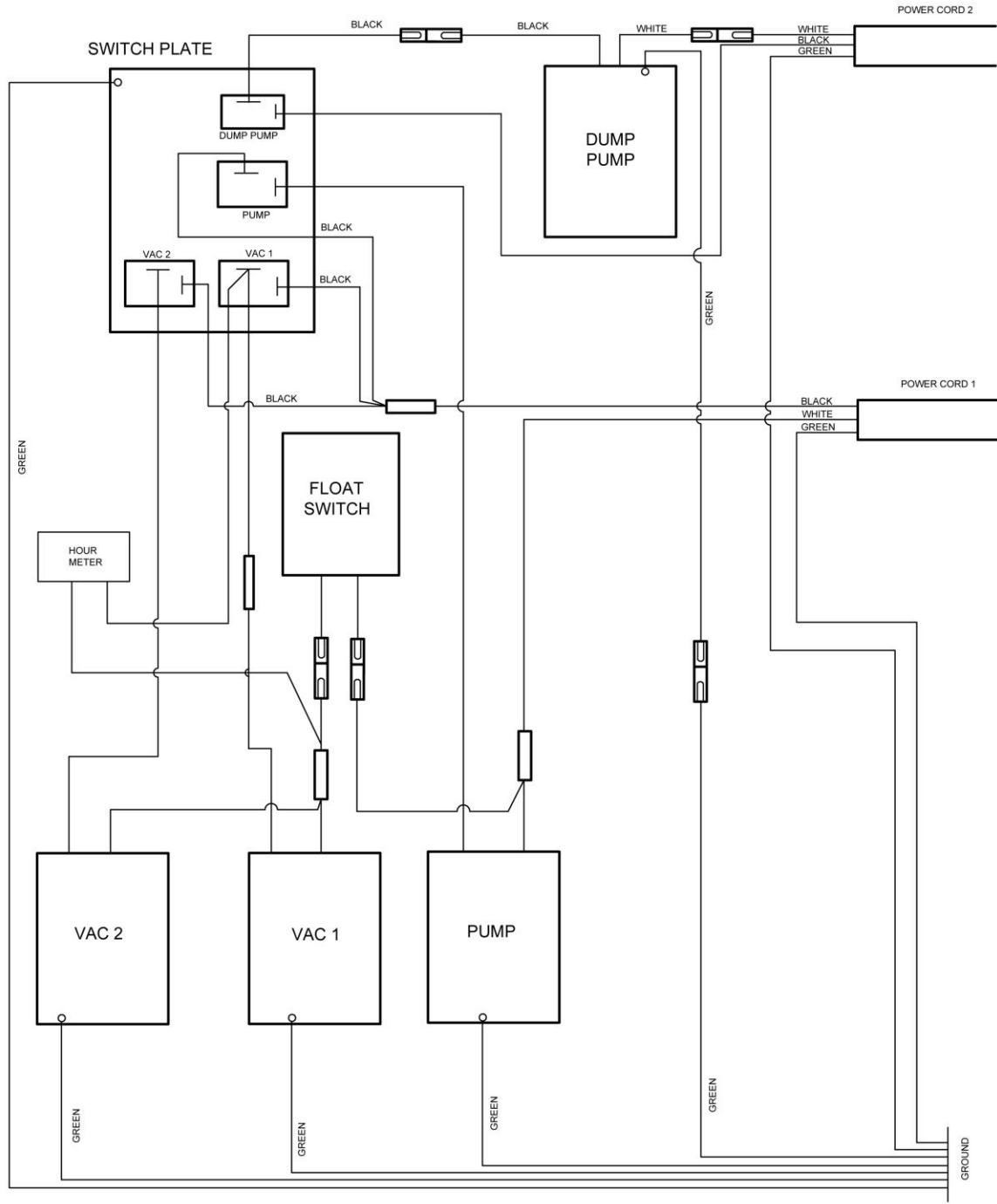

## PUMP TROUBLE SHOOTING GUIDE

TROUBLE	PROBABLE CAUSE	TO CORRECT
Pump starts but no prime	<ol style="list-style-type: none"> <li>1. Not enough volt</li> <li>2. No liquid</li> <li>3. Leak in inlet line</li> <li>4. Air lock</li> <li>5. Bad valves</li> <li>6. Mounted too high</li> <li>7. Check valve stuck</li> <li>8. Debris in pump</li> <li>9. Clogged filter</li> <li>10. Line connection backward</li> <li>11. Missing VLV. HSG O-ring</li> </ol>	<ol style="list-style-type: none"> <li>1. Provide correct volt</li> <li>2. Fill liquid</li> <li>3. Correct leak</li> <li>4. Bleed air</li> <li>5. Replace valves</li> <li>6. Lower mounting</li> <li>7. Clean/replace ck. Valve</li> <li>8. Clean/replace damaged parts</li> <li>9. Clean/replace filter</li> <li>10. Connect line to proper port</li> <li>11. Replace O-ring</li> </ol>
External Leak from pump head drain	<ol style="list-style-type: none"> <li>1. Ruptured diaphragm</li> <li>2. Piston SC loose</li> <li>3. Pinched diaphragm</li> <li>4. Cross thread piston scr.</li> </ol>	<ol style="list-style-type: none"> <li>1. Replace diaphragm</li> <li>2. Tighten Piston screw</li> <li>3. Replace diaphragm</li> <li>4. Properly assemble</li> </ol>
External leak from switch	<ol style="list-style-type: none"> <li>1. Ruptured SW diaphragm</li> <li>2. Pinched SW diaphragm</li> <li>3. Loose switch screw</li> </ol>	<ol style="list-style-type: none"> <li>1. Replace SW diaphragm</li> <li>2. Replace SW diaphragm</li> <li>3. Secure switch screw</li> </ol>
Vacuum leak	<ol style="list-style-type: none"> <li>1. Pinched diaphragm</li> <li>2. Cracked upper hsg</li> <li>3. Loose inline fitting</li> <li>4. Cracked valve housing</li> </ol>	<ol style="list-style-type: none"> <li>1. Replace diaphragm</li> <li>2. Replace upper housing</li> <li>3. Tighten fitting</li> <li>4. Replace valve housing</li> </ol>
Rough pump	<ol style="list-style-type: none"> <li>1. Bad motor</li> <li>2. Bad drive</li> <li>3. Screws loose</li> </ol>	<ol style="list-style-type: none"> <li>1. Replace</li> <li>2. Replace</li> <li>3. Tighten screws</li> </ol>
Low performance	<ol style="list-style-type: none"> <li>1. Clogged filter</li> <li>2. Bad motor</li> <li>3. Improper voltage</li> <li>4. Bad valves</li> <li>5. Improper plumbing</li> <li>6. Loose fasteners</li> </ol>	<ol style="list-style-type: none"> <li>1. Clean/replace</li> <li>2. Replace</li> <li>3. Provide proper voltage</li> <li>4. Replace</li> <li>5. Correct plumbing</li> <li>6. Secure all fasteners</li> </ol>

## PUMP TROUBLE SHOOTING GUIDE

<b>TROUBLE</b>	<b>PROBABLE CAUSE</b>	<b>TO CORRECT</b>
Pump will not start	<ol style="list-style-type: none"><li>1. Bad motor</li><li>2. Bad rectifier</li><li>3. Bad wire connection</li><li>4. Bad micro switch</li><li>5. Bad brushes</li><li>6. Frozen drive</li><li>7. Blown fuse</li><li>8. No power to pump</li></ol>	<ol style="list-style-type: none"><li>1. Replace</li><li>2. Replace motor</li><li>3. Correct connection</li><li>4. Replace</li><li>5. Replace motor</li><li>6. Replace drive</li><li>7. Replace</li><li>8. Connect power</li></ol>
No shut off	<ol style="list-style-type: none"><li>1. No Liquid</li><li>2. Air lock</li><li>3. Shut set too high (By-pass SW combination)</li><li>4. Bad micro switch</li></ol>	<ol style="list-style-type: none"><li>1. Fill liquid</li><li>2. Purge line check installation</li><li>3. Set to correct shutoff</li><li>4. Replace</li></ol>



## WARRANTY REGISTRATION / DELIVERY ACCEPTANCE

This form must be completed and returned to Esteam Cleaning Systems to activate your warranty.

Esteam would like to take this opportunity to point out a few operating and safety recommendations for your consideration.

\* All units cords have a ground plug pin for your safety, never remove or operate any equipment if the ground pin on the plug has been removed.

\* Defoamer is to be used in all machines. Improper use of chemicals will void warranty. Drycleaning solvents cannot be used in any Esteam extractors.

\* Do not over fill recovery tanks as this will damage the vacuum motors. Vacuum motors showing any signs of moisture contamination will not be covered under warranty.

Model # \_\_\_\_\_ Serial # \_\_\_\_\_

Name: \_\_\_\_\_

Address: \_\_\_\_\_

City: \_\_\_\_\_ Province/State: \_\_\_\_\_

Postal Code/Zip: \_\_\_\_\_ Date of Purchase: \_\_\_\_\_  
Month / Day / Year

Purchased From: \_\_\_\_\_

By signing this form I \_\_\_\_\_, accept the terms and conditions of the warranty.  
(print)

I have been fully instructed in the safe operation and use of this equipment.

Signed: \_\_\_\_\_ Date: \_\_\_\_\_

Mail Warranty Registration / Delivery Acceptance to:

Esteam Manufacturing Ltd.  
3750-19th Street NE  
Calgary, Alberta, Canada  
T2E 6V2

Or Fax to:  
(403) 291 - 0546

# **ESTEAM® CLEANING SYSTEMS FLOOD MASTER WARRANTY**

**NOTICE: REVIEW THIS WARRANTY CAREFULLY AS THIS DOCUMENT CONTAINS LIMITATIONS AND EXCLUSIONS.**

## **PART I:**

Esteam Manufacturing Ltd. (hereinafter referred to as "Esteam") warrants each new Flood Master, subject to the limitations as defined in the specific details of its warranty coverage defined below.

### **LIMITED LIFETIME HOUSING WARRANTY COVERAGE:**

Esteam warrants the Flood Master Polyethylene Machine Housing Unit to be free from defects in material and workmanship (including cracking, leaking or deterioration) for the life of the unit, expressly subject to the limitations stated herein.

In the event a defect occurs in a Flood Master Housing Unit within five years of receipt by the original customer, Esteam will, if satisfied on its examination that the failure is due to defective material or workmanship, repair or replace the Flood Master Housing Unit, at no cost to the original customer, other than as maybe provided for in this warranty.

In the event a defect occurs in a Flood Master Housing Unit subsequent to five years (and thereafter for life) of receipt by the original customer; Esteam will, if satisfied on its examination, that the failure is due to defective material or workmanship, provide to the original customer only, a new Housing Unit, at 50% of the then published retail pricing basis, used by Esteam.

### **90 DAY LIMITED WARRANTY COVERAGE:**

Esteam warrants all switches, vacuum hoses and solution hoses to be free from defects in material and workmanship, for any defect occurring within 90 days of receipt by the original customer of the Flood Master; and further subject to the limitations stated below. 90 day on labor, subject to Esteam's approval; hourly labor credit is set by Esteam.

### **12 MONTH WARRANTY COVERAGE:**

Subject to the Limited Lifetime Warranty and the 90 Day Limited Warranty; Esteam warrants all remaining items on the Flood Master to be free from defect in material or workmanship (excluding any labour charges) for a period of 12 months from date of receipt of the unit by the original customer; and further subject to the limitations stated below.

## **PART II - REPLACEMENT PARTS (UNDER WARRANTY)**

Replacement warranty parts will be genuine Esteam parts, or parts of similar kind and quality. All replacement warranty parts are warranted to be free from defects in materials or workmanship from the date of the original unit purchase for the balance of the original warranty period namely: 90 days, 12 months, or the Lifetime, whichever is applicable; all in accordance with the terms of Part I, of this warranty.

## **PART III - LIMITATIONS ON WARRANTY COVERAGE**

### **WHAT IS NOT COVERED:**

Notwithstanding any other term or covenant of Esteam contained herein, the following provisions shall apply:

- (i) No warranty is provided for any Esteam product which has failed as a result of freezing, fire, misuse, alteration, improper amps or voltage, accidental damage, improper maintenance, unauthorized repairs, alterations, abuse, neglect or operation of a Esteam product not expressly recommended or contemplated by Esteam; and
- (ii) No warranty is provided for mechanical or electrical breakdown caused by scale, hard water buildup, improper use of chemicals or resins, damage due to environmental conditions, and acts of God, or other events beyond the control of Esteam; and
- (iii) No warranty is provided for mechanical or electrical breakdown or failure of an Esteam product resulting from ordinary wear and tear, or the consequences thereof; including but not limited to the gradual reduction of the operating performance of the product. The determination of what is or is not ordinary wear and tear is at the sole discretion of Esteam; and
- (iv) No warranty is provided for damage caused by the failure of non-warranted parts and/or accessories, even if warranted parts are damaged as a result of the failure of a non-warranted part; and
- (v) No warranty is provided for damage resulting from failure by the customer to maintain scheduled maintenance requirements. The Esteam system has many parts which must either be replaced or checked for wear on a regular basis; including but not limited to replacement filters and lubricants. This system requires regular maintenance, service and attention by the customer; and
- (vi) No warranty is provided as to any extra expenses incurred by the customer, including but not limited to economic, incidental, consequential loss or damage (e.g. all labour charges, rental equipment, down time, lodging, commercial or business loss of any nature or kind due to product failure); whether direct or indirect, exemplary or punitive damage or loss, and whether in contract, tort or otherwise; and
- (vii) No warranty is provided as to failure of any cosmetic item or finish, labeling, silk screening, decals, paint, trim or other similar decorative items.
- (viii) Brass, rubber and synthetic rubber parts (e.g. "O" rings, diaphragms, gaskets, seals, grommets) are considered expendable in normal use, and are therefore not included in any warranty by Esteam.



## **PART IV - EXCLUSION OF LIABILITY**

Esteam makes no warranties or representations, either expressed or implied, oral or written, in fact, or by operation of law, or otherwise, except as expressly stated herein as to the 90 day Limited, 12 month and Lifetime Extended warranties. Esteam, its officers, directors, agents, dealers and its affiliates (and their respective officers, directors, agents and dealers) shall not be liable to the customer nor to any party for any liability, including without limitation, strict liability, liability for loss, injury or damage due directly or indirectly to the use or operation of the Esteam product; consequential, exemplary and/or punitive damage or loss, whether in contract, tort, or otherwise.

## **PART V - RETURN GUIDELINES**

Defective items must be replaced through a local Esteam Distributor. Replacement parts will be sent via prepaid regular ground service to the distributor. The defective part must be returned F.O.B. factory within 30 days including a letter providing the machine's serial number, date of purchase, material return authorization number, and customer name. If applicable, credit will be issued after the item has been evaluated by Esteam. Failure to comply with return policy will void the warranty on that item.

## **PART VI - CREDIT POLICY**

All customers purchasing parts through an Esteam distributor must arrange credit directly with that distributor.

## **PART VII - OUTSIDE SOURCE WARRANTY REPAIRS**

At the sole discretion of Esteam, it may be necessary to perform warranty/repairs at an outside source. An estimate must be submitted to and approved by Esteam prior to work being performed. Failure to do so will result in denial of your warranty claim.

## **PART VIII - TRANSFERABILITY**

This warranty is not transferable to any subsequent owner.

## **PART IX - NOTICE - CUSTOMER OBLIGATIONS**

- (i) Your responsibility as a customer includes but is not limited to cleaning, lubricating, seasonal maintenance (e.g. winterizing), replacement of worn parts and all regular scheduled or unscheduled maintenance.
- (ii) Any claim for warranty must be presented to Esteam or its authorized dealer, prior to the expiration of the time limitations specified and not thereafter, otherwise any warranty is void.
- (iii) Notwithstanding the generality of the foregoing customer obligations, Esteam does hereby bring to the attention of the customer, these specific maintenance operating requirements of the Flood Master to validate its warranty:

(a) Chemical Warning:

Any improper use of chemicals shall void any Esteam warranty and thusly exclude any liability by Esteam. No dry cleaning chemical may be used in a Flood Master as any such use may result in fire or pump/motor damage. A defoamer solution must be used by customer to limit foaming in the recovery tank.

(b) Vacuum Motors:

Require use of a defoamer. A vacuum motor showing moisture contamination on interior components shall void any warranty by Esteam.

(c) Pumps:

All pumps require daily flushing with clean water after use.

Further on the 200 PSI Pumptec pump, a 3 AMP fuse is used to protect this motor; and the pressure regulator must not be tampered with to exceed a higher operating pressure than the 200 PSI maximum allowed.

The foregoing constitutes Esteam's entire warranty and no other warranty, liability, contingency or responsibility, direct, indirect, consequential or in any other way connected with the sale or operation of Esteam machines or chemical product is expressed or implied.

**Flood Master Warranty**  
**Esteam Manufacturing Ltd. 3750-19th Street NE**  
**Calgary, AB T2E 6V2 1-800-653-8338**